

# Panasonic®

## Reference Manual

Personal Computer

Model No. **CF-H1 Series**

---



We recommend that this Reference Manual be printed.

## Terms and illustrations in this manual

→ : Page in this Manual.

**CAUTION** : Conditions that may result in minor or moderate injury.

**NOTE** : Useful and helpful information.

**Click** : Touch the screen with the digitizer pen or finger.

**Right-click** :

Touch and hold with the digitizer pen.

You can also perform “Right-click” by pressing and holding the button of the digitizer pen, and then tapping the object.

**[start] - [All Programs]** :

Click [start], and then click [All Programs].

**<Only when connected to Cradle and keyboard>**

**↵** : Press [↵] (Enter) key.

**Ctrl + F7** :  
Press and hold **Ctrl** key, and then press **F7** key.

## Regarding Windows XP

- Do not set [Command Prompt] to “Full Screen”.

You can use Windows by touching the screen in the same way as you use a mouse. The screen of this computer has following two pointing device functions.

- Digitizer: can be operated with the digitizer pen (included)
- Touchscreen: can be operated with your finger etc.

If you touch the screen with the digitizer pen and your finger at the same time, the operation by the digitizer pen is enabled.

## ● To right-click

### <When using the digitizer pen (included)>

You can perform “Right-click” with either of operation below.

- Touch and hold with the digitizer pen.
- Press and hold the button (A) of the digitizer pen, and then touch the object.

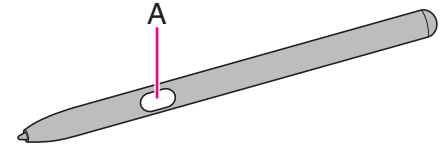

### <When not using the digitizer pen>

- Place the mouse pointer on the object, then press [A3] button.

## NOTE

- The operation by touching the screen does not work in the Setup Utility.

### <Model with Barcode Reader>

- If you do not use the digitizer pen, we recommend to assign [Right Click] to the application button [A1] or [A2].  
(→ [page 11](#))

## Operation by touching the screen

### ● Touch the screen with the digitizer pen (included) or your finger

When touching the screen, use only the digitizer pen (included) or your finger on the surface.

Touching the screen with an object other than the digitizer pen (included) or your fingertip may scar or stain the surface, causing the malfunction.

### ● Do not apply too much pressure when touching the screen

Only a light touch is required to touch the screen. Applying too much pressure may damage the surface.

## Maintaining the performance of the screen

### ● When the screen becomes dirty, wipe it with a soft cloth

The screen is specially treated to prevent dirt from adhering to the surface, so dirt can be removed easily using a dry cloth. If the dirt does not come off easily, breathe on the surface and try again.

Do not apply water or solvents to the soft cloth.

- **Check the following to prevent the surface of the screen from being scratched**
  - Are you using the digitizer pen or your finger to operate the screen?
  - Is the surface clean?
  - Is the cloth clean?
  - Is the tip of the digitizer pen clean?
  - Is your finger clean?

## Things to keep in mind when using the screen

- **Do not touch the screen outside of the LCD display area**

The input area is defined by the LCD display screen. Touching the screen outside of the display area may result malfunctions or damage to the screen.
- **Do not apply excessive force to the screen**

Do not lift the computer while holding the LCD screen, or allow the screen to be twisted. Do not place any objects on the LCD screen. Any of the above may cause the screen glass to break, or may damage the LCD screen.
- **Operation response may be slower in low temperature environments**

The screen may respond to operations more slowly when using the computer in temperatures less than 5°C, but this is not a malfunction. Response time will return to normal when the computer is returned to room temperature.
- **If the cursor jumps to a location other than where the screen was touched, or if the LCD resolution changes, perform the calibration**

Perform the procedure of “Calibration” (→ [page 5](#)).

## Calibration

### ■ Digitizer Calibration

To calibrate the digitizer, use the digitizer pen and follow the steps below.

- 1** Click [start] - [Control Panel] - [Printers and other Hardware].
- 2** Click [Tablet and Pen Settings].
- 3** Click [Calibrate...] in [Settings].
- 4** Using the digitizer pen, touch each of 4 “+” target marks one by one, and then click [OK].

### ■ Touchscreen Calibration

To calibrate the touchscreen, use your finger or other objects and follow the steps below. Do not use the digitizer pen.

- 1** Click [start] - [All Programs] - [InPlay] - [Calibration].
- 2** Using your finger or other objects, touch each of 9 “+” target marks one by one, and then click [OK].

#### NOTE

- Perform the following calibration for each user.

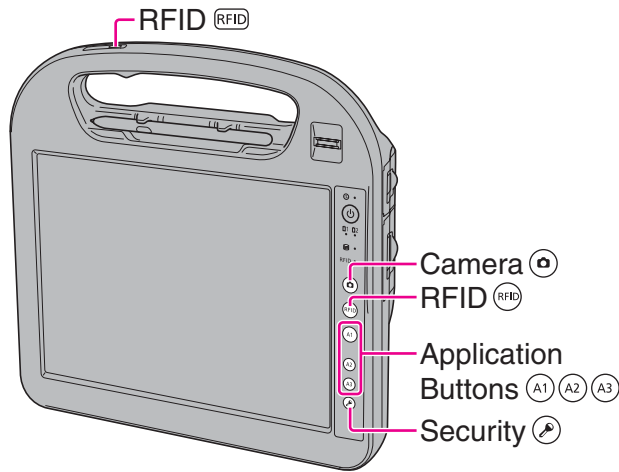

<Model Without Barcode Reader>

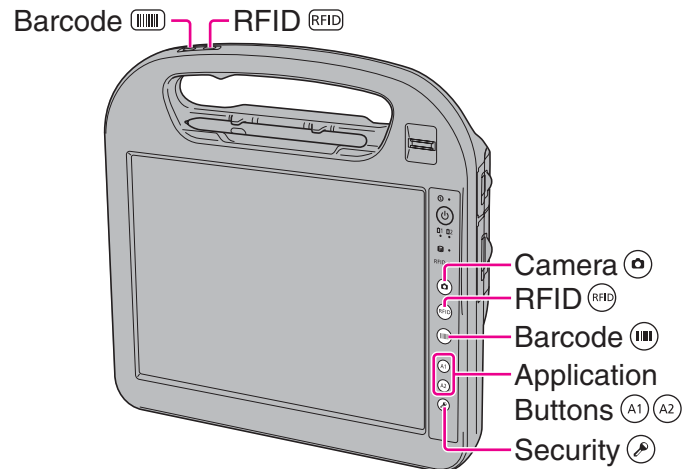

<Model with Barcode Reader>

Button	Function
	<b>Camera Button</b> Take still pictures. (→ <a href="#">page 30</a> )
 	<b>RFID Reader Button</b> Read the data from RFID tags. (→ <a href="#">page 31</a> )
*1 *1	<b>Barcode Reader Button</b> Read the barcode.
  *2	<b>Application Buttons</b> Start the registered function or application. (→ <a href="#">page 11</a> )
	<b>Security Button</b> Works as <b>Ctrl + Alt + Del.</b>

\*1 Only for model with the Barcode Reader

\*2 Only for model without the Barcode Reader

## NOTE

---

- The Hardware buttons work when the Windows screen is displayed.
  - The Hardware buttons may not work immediately after Windows is started up or the Windows logon screen (or the Welcome screen) is displayed.
-

You can perform the following operations by using Panasonic Dashboard.

- Check the remaining battery charge
- Change the LCD brightness
- Change the camera light settings
- Change the screen color of Cleaning Utility
- Enable or disable the touchscreen operation
- Start the application software which you registered
- Change the settings of cleaning reminder, RFID, touchscreen, button assignment of Panasonic Dashboard and application buttons

## 1 Press the application button [A2]\*1 (A).

You can also start Panasonic dashboard by clicking  icon on the notification area and click [Settings...].  
Panasonic Dashboard starts up.

\*1 You can change the setting of application button (→ [page 11](#)).

## 2 Make the operation.

### [Battery] (B)

You can check the remaining battery charge.

### [Brightness] (C)

You can change the LCD brightness.

The brightness can be changed by clicking the desired position of the bar.

The brightness for battery operation and AC power operation can be set separately.

### [Camera Light] (D)

- To display the light switch while using the camera, add a check mark for [Automatically display the light switch while using the camera].
- To turn on the light when the preview starts, add a check mark for [Always turn the light ON when the preview starts].

### [Cleaning Utility] (E)

You can change the screen color of Cleaning Utility. When a check mark for [Half transparent] is added, Windows screen seems to be transparent of the screen color.

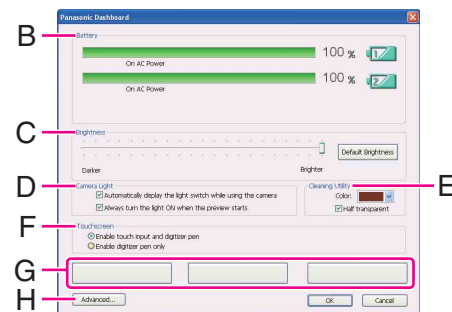
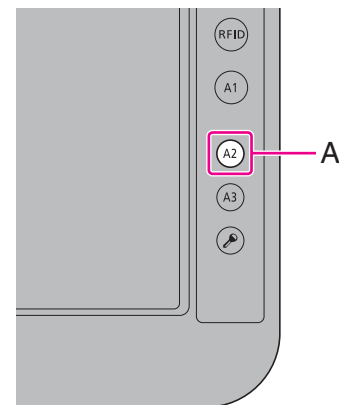



## [Touchscreen] (F)

When a check mark for [Enable digitizer pen only] is added, you can use only the digitizer pen (included) to operate by touching the screen. You cannot use the other stylus or the finger. We recommend to add a check mark for this, when you place the palm on the screen and touch the screen by using the digitizer pen.

This setting is stored for each user.

## Software buttons (G)

You can start the application software which you registered. You can change the registered application by using [Advanced] menu. (→ below)

## [Advanced...] (H)

You can select [Advanced] only if you logged on to Windows as an administrator.

[Advanced Settings] menu is displayed. You can change the following settings.

After making settings in [Advanced Settings], click [OK] to exit [Advanced Settings].

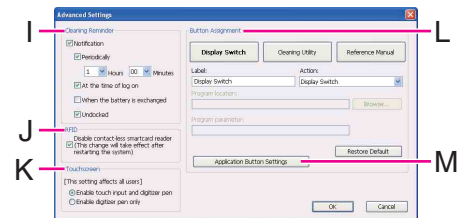

## [Cleaning Reminder] (I)

You can regularly display the message to remind cleaning. Some of following conditions can be selected.

- [Periodically]  
When the defined time has passed since the last cleaning was performed.
- [At the time of log on]  
When you log on to Windows.
- [When the battery is exchanged]  
When you change the battery.
- [Undocked]  
When you undock this computer from the Cradle.

## [RFID] (J)

When a check mark is added, the data will be read only when RFID reader button is pressed.

When the check mark is removed, the RFID reader reads the data constantly.

## [Touchscreen] (K)

When a check mark for [Enable digitizer pen only] is added, you can use only the digitizer pen (included) to operate by touching the screen. You cannot use the other stylus or the finger. We recommend to add a check mark for this, when you place the palm on the screen and touch the screen by using the digitizer pen.

This setting affects all users.

## [Button Assignment] (L)

You can register the executable files or the applications to the buttons displayed on Panasonic Dashboard screen.

- ① Click any button.
- ② Select the application from [Action].  
You can select [Display Rotation], [Cleaning Utility], [Reference Manual] or [Launch Application]. To restore the default setting, click [Restore Default].  
When you select [Launch Application], input the label to [Label] box, and select a file you wish to execute.
  - You can also select files with extensions .pdf, .jpeg, .wma, etc. other than .exe.
  - When you select a file with extension .exe, you can specify the parameter into [Program parameter].
  - To disable the application, make the text box blank.

## **[Application Button Settings] (M)**

“Application Button Settings” (→ [page 11](#))

- 3** Click [OK] to close Panasonic Dashboard.

You can assign the startup functions of your favorite applications to the Applications Buttons.

**1 Click [start] - [All Programs] - [Panasonic] - [Application Button Setting].**

You can also start up Application Button Setting Utility from Panasonic Dashboard (→ [page 8](#)).

**2 Make the settings.**

You can register the execute files of the applications.

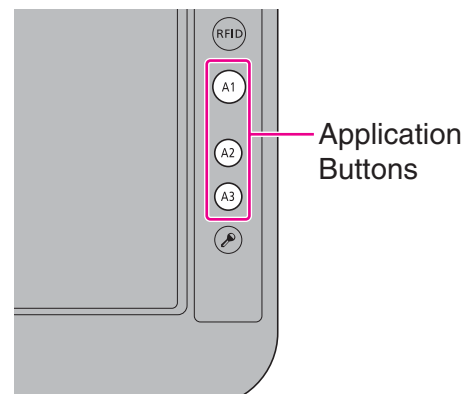

**NOTE**

- <Only for model with Barcode reader>  
Button [A3] is not displayed.

## 1 Select the action from [Action] of each button.

You can select [<none>], [Dashboard], [Display Switch], [Right Click], [Cleaning Utility], [Reference Manual] or [Launch an Application]. To restore the default setting, click [Restore Default].

When you select [Launch an Application], input the label to [Label] box, and select a file you wish to execute.

- You can also select files with extensions .pdf, .jpeg, .wma, etc. other than .exe.
- When you select a file with extension .exe, you can specify the parameter into [Program parameter].
- To disable the application, select [<none>].

## 2 Click [OK].

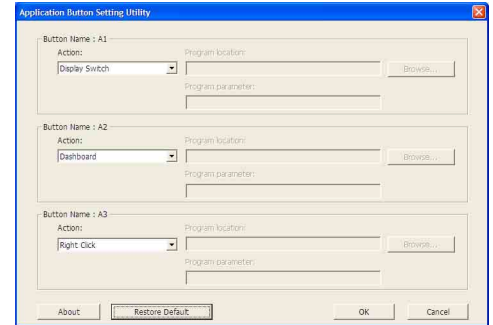

<Model without Barcode Reader>

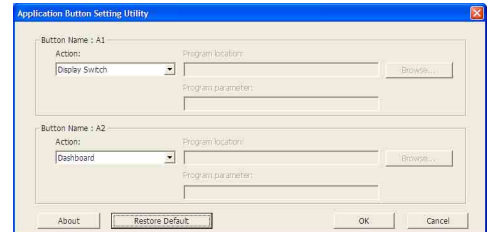

<Model with Barcode Reader>

You can make a bitmap file (.bmp) of a simple character and a figure such as signature by handwriting on the screen.

## CAUTION

- Do not use the Fast User Switching function while Panasonic Hand Writing is active.
- If you install other pointing devices (e.g., commercially available mouse driver), Panasonic Hand Writing will not work.

## NOTE

- The display of Panasonic Hand Writing may be distorted if the number of display colors is changed. Right-click  on the notification area and click [Exit Panasonic Hand Writing], and then restart Panasonic Hand Writing.
- Panasonic Hand Writing may not work properly if another application software is active. In this case, close the application software and try handwriting again.

## Starting Panasonic Hand Writing

### 1 Double-click on the notification area.

Alternatively you can click [start] - [All Programs] - [Panasonic] - [Panasonic Hand Writing].

## NOTE

- Select the image size before handwriting by clicking [Option] - [Window size]. If you change the size after handwriting, the image quality will become lower.
- You can copy the bitmap image by clicking [Edit] - [Copy], and paste it in another application software that supports bitmap format.

## Rotating the Display

### 1 Press [A1] button (A).

Each time you press the button, the screen display rotates counter-clockwise by 90°.

When the computer is set to the Cradle, the screen display does not rotate. If you want to rotate the screen display even if the computer is set to the Cradle, follow the step below.

① Click  on the notification area and click one of the display angles.

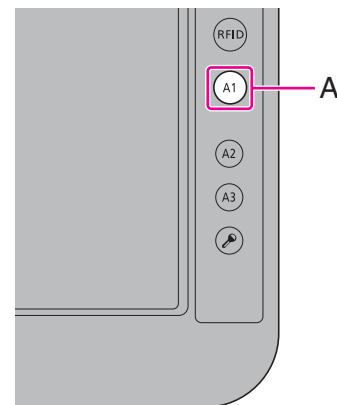

### NOTE

- Alternatively you can rotate the display by the following procedure.  
Click [start] - [Control Panel] - [mobile PC] - [Change screen orientation].
- While the display is rotated:
  - Do not use the Extended Desktop. The touchscreen or digitizer may not work properly.
  - Do not set the resolution larger than that of the internal LCD.
  - The computer's performance is slightly lowered.
- When the display is rotated, the motion video may not be displayed correctly or the sound may be distorted. Return the display angle to [Primary Landscape].
- When you start up Windows and rotate the display right after logging on, the display may return to the previous state in approximately 1 minute. In this case, rotate the display again.

## Starting Up Your Computer Quickly

The standby or hibernation functions allow you to shut off the computer without closing programs and documents. You can quickly return to the programs and documents that you were working on before standby or hibernation.

Function	Data is saved to	Recovery time	Power supply
Standby	Memory	Short	Required. (If power is not supplied, all data will be lost.)
Hibernation	Hard disk	Rather long	Not required. (However power is slightly consumed to keep the hibernation.)

## Setting Standby or Hibernation

- 1 Click [start] - [Control Panel] - [Performance and Maintenance] - [Power Options] - [Advanced].
- 2 Select [Stand by] or [Hibernate] for [When I press the power button on my computer], and then click [OK].

### NOTE

- You need to make the setting if you want to use hibernation function.

## Precautions

- Connect the AC adaptor if the computer will be in standby for a long period of time. If you cannot use the AC adaptor, use hibernation instead.
- Using standby or hibernation repeatedly may cause malfunction of the computer. To stabilize computer operation, restart Windows regularly (about once a week) without using standby or hibernation.
- Save the necessary data.
- Close files you have opened from removable disks and network drives.
- It may take 1 or 2 minutes to enter hibernation. Do not touch any key though the screen becomes dark.
- The password you set in the Setup Utility is not requested at resuming. You can use the Windows password for security in standby or hibernation.
  - ① Click [start] - [Control Panel] - [User Accounts], and select the account.
  - ② Click [Create a password] and set the password.

- ③ Click [start] - [Control Panel] - [Performance and Maintenance] - [Power Options] - [Advanced], and add a check mark in [Prompt for password when computer resumes from standby].
- Do not enter standby or hibernation in the conditions below, otherwise the data or file may be corrupted, standby or hibernation may not work, or malfunction may occur in the computer or the peripheral devices.
  - When any of the hard disk drive indicator  and the RFID indicator is on.
  - When playing/recording audio files or displaying motion video such as MPEG files.
  - When using communication software or network functions.
  - When using peripheral devices.  
(If peripheral devices fail to work normally, restart the computer.)

## Entering/Resuming from Standby or Hibernation

### ■ To enter standby or hibernation

#### 1 Press the power switch (A) until a beep<sup>\*1</sup> sounds.

Standby: The power indicator (B) blinks green.

Hibernation: The power indicator (B) goes off.

- To enter standby, you can click [start] - [Turn Off Computer] - [Stand By] instead of pressing the power switch.

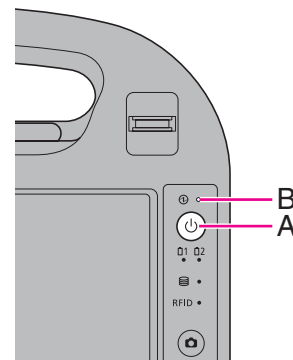

<sup>\*1</sup> If the speakers are muted, beeps do not sound.

### CAUTION

- At the beep<sup>\*2</sup>, immediately release the power switch. If you press and hold the power switch for longer than 4 seconds, the computer will forcibly shut down and unsaved data will be lost even if you have set [Shut down] in [When I press the power button on my computer] (→ [page 15](#) “Setting Standby or Hibernation”).

<sup>\*2</sup> According to circumstances, beeps may not sound.

- While the computer is entering standby or hibernation, do not touch the computer. For example, do not:
  - Touch the screen, hardware buttons or power switch.
  - Use an external mouse or other peripheral devices.
  - Connect or disconnect the AC adaptor.
  - Set to or remove from the Cradle.

Wait until the power indicator blinks green (standby) or goes off (hibernation).



- It may take 1 or 2 minutes to enter standby or hibernation.

## In standby or hibernation

- Do not attach or remove a peripheral device (including the Cradle). Doing so may cause malfunction.
- Power is consumed in standby. When power is exhausted, the data retained in memory will be lost. Connect the AC adaptor when using the standby function.

## ■ To resume from standby or hibernation

- 1 Press the power switch(A).

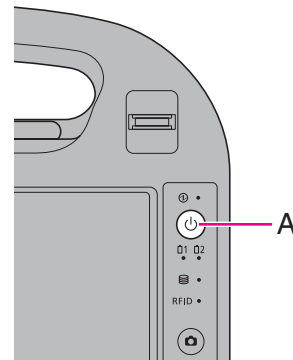

## CAUTION

- Do not perform the following operations until resuming is complete. After the display is resumed, wait approximately 30 seconds (normally) or 60 seconds (when the computer is on a network).
  - Touch the screen, hardware buttons or power switch.
  - Use an external mouse or other peripheral devices.
  - Connect or disconnect the AC adaptor.
  - Shut down or restart Windows.
  - Enter standby or hibernation (Wait approximately 1 minute).
  - Set to or remove from the Cradle.

## NOTE

- After resuming from standby or hibernation, the message “TosBtMng has stopped working” may appear. Click [Close program].  
If Bluetooth connections are cut off, click [start] - [All Programs] - [Bluetooth] - [Bluetooth Settings], and connect to the Bluetooth devices again.

You can extend battery life and save power also during AC adaptor usage.

## Reducing Power Consumption

Use the methods below to reduce power consumption.

- **Change [Power Options]**

Click [start] - [Control Panel] - [Performance and Maintenance] - [Power Options] to select [Max Battery] under [Power schemes].

While [Portable/Laptop] is selected under [Power Options] as the factory default, selecting [Max Battery] will further reduce power consumption.

Also, make detailed settings such as reducing the time entered in the [Turn off monitor] setting.

- **Reduce LCD brightness by using Panasonic Dashboard**

Reducing internal LCD brightness will reduce power consumption.

- **Turn off the computer when it is not in use**

You can also turn off only the wireless LAN, wireless WAN (only for model with wireless WAN) or Bluetooth power.

- **Disconnect external devices (USB devices, external mice, etc.) that are not being used**

- **Use Standby/Hibernation**

Enter to standby or hibernation when you have to leave the computer. This shuts down computer operation to reduce power consumption.

Use these features to protect your data.

## Setting the Supervisor Password/User Password

Set the Supervisor Password before setting the User Password.

### Preparation

- Set the computer to the Cradle and connect an external keyboard to the Cradle.

**1** Start up the Setup Utility (→ page 53).

**2** Select [Security].

**3** Select [Set Supervisor Password] or [Set User Password], and press **↵** (Enter).

**4** Enter your password in [Enter New Password] and press **↵** (Enter).

- When the password has been set, you need to enter your password in [Enter Current Password] and press **↵** (Enter).
- To disable the password, leave the input field empty and press **↵** (Enter).

**5** Enter your password again in [Confirm New Password] and press **↵** (Enter).

**6** In [Setup Notice], press **↵** (Enter).

**7** Press **F10**, and then select [Yes] and press **↵** (Enter).

### CAUTION

- Do not forget your password. If you forget your Supervisor Password, you will not be able to use your computer. Contact Panasonic Technical Support.
- When running the Setup Utility, do not leave and go away from your computer even for a short time, since other people may set or change the password.

### NOTE

- The password will not be displayed on the screen.
- You can use up to 32 alphanumeric characters (including spaces).
  - The case (upper/lower) is ignored.
  - Use only the upper horizontal row of numeric keys to input your password.
  - You cannot use **Shift** and **Ctrl** to input a password.
- Disabling the Supervisor Password also disables the User Password.

## Preventing Your Computer from Unauthorized Use

You can set a start-up password to protect your computer from unauthorized use.

- 1 **Set the password (→ page 19), and select [Enabled] in [Password on Boot] in the [Security] menu of the Setup Utility (→ page 58).**

### NOTE

- To enter the password, you need to set the computer to the Cradle and connect an external keyboard to the Cradle.
- If the Supervisor Password or User Password has been set, the password input screen will be displayed on starting-up of the Setup Utility even though [Password on Boot] is set to [Disabled].

## Preventing Your Hard Disk Data from Being Read or Written

The hard disk lock function protects the hard disk data from being read or written when the hard disk is attached to another computer. The data can be read/written when the hard disk is returned to the original computer.

- 1 **Select [Enabled] in [Hard Disk Lock] in the [Security] menu of the Setup Utility (→ page 58).**

### CAUTION

- For the data being read/written on the original computer, the Setup Utility settings must be the same as when the hard disk was removed.
- You cannot use the hard disk lock function without setting the Supervisor Password. Set the Supervisor Password beforehand (→ page 19).
- When you have your hard disk drive repaired
  - Contact Panasonic Technical Support.
  - Before sending back the hard disk drive, be sure to set the [Hard Disk Lock] to [Disabled].

### NOTE

- The hard disk lock function works with the built-in hard disk. It does not work with the external hard disk.
- Note that the hard disk lock does not guarantee complete protection of the data.

## Battery Indicator

You can attach 2 battery packs to this computer. The battery indicators are prepared for each battery.

**A** : Battery 1 indicator

**B** : Battery 2 indicator

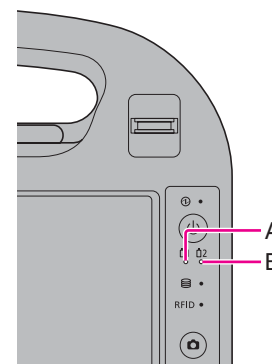

Battery indicator	Battery status												
Not lit	The battery pack is not inserted or not being charged. <ul style="list-style-type: none"> <li>You can check presence of the battery pack by using Panasonic Dashboard (→ page 8)</li> </ul>												
Orange	Charging is in progress.												
Green	The battery is fully-charged.												
Blinking green	<p><b>When you attach the battery cover with the battery pack already inserted:</b></p> <ul style="list-style-type: none"> <li>You can check the battery level by blinking times</li> </ul> <table border="1"> <thead> <tr> <th>Blinking times</th> <th>Battery level</th> </tr> </thead> <tbody> <tr> <td>5 times</td> <td>95 % to 100 %</td> </tr> <tr> <td>4 times</td> <td>50 % to 94 %</td> </tr> <tr> <td>3 times</td> <td>25 % to 49 %</td> </tr> <tr> <td>2 times</td> <td>5 % to 24 %</td> </tr> <tr> <td>1 time</td> <td>0 % to 4 %</td> </tr> </tbody> </table> <p><b>Except for the operations stated above:</b></p> <p>In high temperature mode, the battery pack is discharging the power to 80%<sup>*1</sup> of normal temperature mode (→ page 24). Do not remove the battery pack since the power is not supplied even if you connect the AC adaptor in this status. If remove the battery pack, the computer will be turned off and lose data.</p> <p><sup>*1</sup> In high temperature mode, the 100% battery level is equivalent to 80% level of the normal temperature mode.</p>	Blinking times	Battery level	5 times	95 % to 100 %	4 times	50 % to 94 %	3 times	25 % to 49 %	2 times	5 % to 24 %	1 time	0 % to 4 %
Blinking times	Battery level												
5 times	95 % to 100 %												
4 times	50 % to 94 %												
3 times	25 % to 49 %												
2 times	5 % to 24 %												
1 time	0 % to 4 %												

Battery indicator	Battery status
<b>Red</b>	The remaining battery is approximately 9% or less.
<b>Blinking red</b>	<p><b>When blinking approx. every 1 second:</b> The battery pack or the charging circuit is not operating properly.</p> <p><b>When blinking approx. every 4 second:</b> The battery cover is open. You can remove the battery pack in this case.</p> <p><b>When blinking approx. every 0.5 second:</b> The battery cover is open. If you remove the battery pack in this case, the power supply is cut off and the computer is shut down. Close the battery cover immediately.</p>
<b>Blinking orange</b>	<p>The battery cannot be charged temporarily due to the following reasons:</p> <ul style="list-style-type: none"><li>• Its internal temperature is out of the acceptable range.</li><li>• The power supply is not enough because software applications or peripheral devices are consuming a large amount of power.</li></ul>

## NOTE

- Once the battery is fully charged, the computer performs recharging only when the battery level becomes less than approximately 95%, so overcharging is avoided.

## Checking the Remaining Battery Charge

You can check the remaining battery charge on the screen.

(After logging on to Windows)

### 1 Start up Panasonic Dashboard.

- When the battery pack is inserted (example)

	Normal temperature mode (→ page 24)	High temperature mode (→ page 24)
<b>In charging</b>		
<b>In discharging</b> (The battery pack in the frame is discharging)		

- When the battery pack is not inserted

Normal temperature mode (→ page 24)	High temperature mode (→ page 24)

### NOTE

- The battery display may not correspond to the actual remaining battery charge in the cases as below. To correct the display, perform the Battery Recalibration (→ page 26).
  - The battery indicator remains red.
  - The indicator lights orange and the display shows 99% for a long time.
  - Low battery warning appears soon after a short time of use.

This can occur when the computer is in standby for a long time without power supply from the AC adaptor.
- The battery display may not be the same as that of notification area or of [Power Meter] in [Power Options Properties]. This is not a malfunction.

## High temperature mode

---

The high temperature mode can prevent the battery from deteriorating when the computer is used in high-temperature environment or used for a long time with its battery fully charged.

Select [Auto] (default) or [High Temperature] in [Environment] of the [Main] menu of the Setup Utility (→ [page 55](#)).

### NOTE

- Note that a level corresponding to a 100% charge for high temperature mode is approximately equivalent to an 80% charge level for normal temperature mode.
  - After switching from [Normal Temperature] to [High Temperature] or vice versa, the remaining battery capacity will not be displayed correctly until the battery pack is completely discharged or fully charged.
  - In the [Auto] mode:  
Once the computer has automatically switched from the normal temperature mode to the high temperature mode, the computer will not switch back to the normal temperature mode until the battery has been used and recharged to a total charge level of about 5 times as much as that of the fully-charged state. This is to avoid battery deterioration.  
In [Auto] mode, mode switching is possible only for the battery pack in operation. The other battery's [Environment] mode remains the same.
-



## Computer behavior with low battery

The default settings are as follows.

- This computer automatically switches from Battery 1 to Battery 2 and vice versa when either remaining battery charge becomes less than 10%. When both batteries are not sufficiently charged, the computer operates as below.

<b>When the battery level becomes 10% [Low battery alarm]</b>	<b>When the battery level becomes 5% [Critical battery alarm]</b>
<ul style="list-style-type: none"><li>● Displays a message that the battery level is low.</li></ul> <p style="text-align: center;">↓</p>	<ul style="list-style-type: none"><li>● The computer enters hibernation.</li></ul> <p style="text-align: center;">↓</p>
Charge the battery.	Connect the AC adaptor or replace the battery to start up the computer.
<ul style="list-style-type: none"><li>● Connect the AC adaptor immediately. If you do not have the AC adaptor, close the application and turn off the computer, then confirm that the power indicator is off.</li><li>● If you have a fully charged spare battery, turn off the computer, replace the battery and turn the computer on again.</li></ul>	<ul style="list-style-type: none"><li>● Connect the AC adaptor and charge the battery.</li><li>● If you have a fully charged spare battery, replace the battery and turn the computer on again. Do not resume from hibernation until the battery is charged or replaced.</li></ul>

## Correcting the Battery Display (Battery Recalibration)

The “Battery Recalibration” function measures and memorizes the battery capacity. To correct the battery display, use this function to fill the battery and then discharge it completely. Perform the procedure at least once immediately after purchasing the computer. Normally the interval of battery recalibration is 3 months. The battery display may not be correct when the battery pack deteriorates after a long time use. In this case, perform the procedure again.

### 1 Connect the AC adaptor.

### 2 Close all the applications.

### 3 Perform “Battery Recalibration”.

- ① Click [start] - [All Programs] - [Panasonic] - [Battery] - [Battery Recalibration].
- ② When the confirmation message appears, click [Start].
  - Frequent recalibration of the battery can degrade the battery. A caution message appears when the battery recalibration is performed at the shorter interval than approximately a month. In this case, cancel the battery recalibration.
- ③ When the message requests shut down of Windows, click [Yes].

The battery recalibration starts.

After the battery pack is fully charged, discharging starts. When the discharging is completed, the power goes off automatically.

After the battery recalibration is finished, normal charging starts.

#### NOTE

- The temperature range should be 10°C to 30°C {50°F to 86°F}.
- The battery recalibration may take a long time due to the large battery capacity. This is not a malfunction.
  - Full charge: Approx. 7 hours with 2 batteries
  - Complete discharge: Approx. 4 hours with 2 batteries
- If the computer is turned off during the battery recalibration (e.g., due to power failure, or accidental removal of the AC adaptor and battery pack), the battery recalibration will not be completed.
- You can also perform the battery recalibration with the following procedure.
  - ① Set the computer to the Cradle and connect an external keyboard to the Cradle.
  - ② Restart the computer.
  - ③ Press and hold **F9** while the [Panasonic] boot screen is displayed just after the computer starts the startup procedure.
  - ④ When the remaining battery capacity is displayed, press **↵** (Enter).
  - ⑤ Follow the on-screen instructions.

## Replacing the Battery Pack

If you have a battery charger (optional), you can remove one battery pack to charge while the other battery pack is operating. The battery pack is a consumable item so the replacement will be necessary. If the battery operation time becomes noticeably short and not recovered even after recalibrating the battery, replace with a new battery.

### CAUTION

- The battery pack is not charged when you first purchase it. Be sure to charge it before using for the first time. Charging starts automatically when the AC adaptor is connected to the computer.
- Use only the specified battery pack with your computer.

### Checking the battery pack that can be replaced/removed

Remove/replace the battery pack under the right conditions according to the chart below because if the computer is mistakenly shut down, this may cause data to be lost and the computer to malfunction.

<b>When the computer is ON or in Standby/Hibernation</b>	When the AC adaptor is not connected	<b>Only one battery pack can be removed/replaced.</b> To check if the battery pack can be removed/replaced: When you open the battery cover, the blinking (red) of battery indicator tells. <ul style="list-style-type: none"> <li>• When blinking approx. every 4 seconds: <b>Can be replaced</b></li> <li>• When blinking approx. every 0.5 second: <b>Cannot be replaced</b></li> </ul>
	When the AC adaptor is connected	<b>Both battery packs can be removed/replaced.</b>
<b>When the computer is OFF</b>		<b>Both battery packs can be removed/replaced.</b>

## 1 Open the battery cover.

- ① Slide the battery cover and open the cover.
  - ② Open the cover.
- Check the blinking (red) status of battery indicator (→ [page 27](#)).

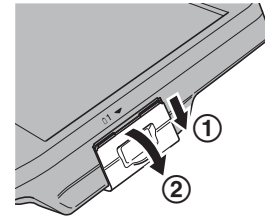

## 2 Pull the tab to remove the battery pack.

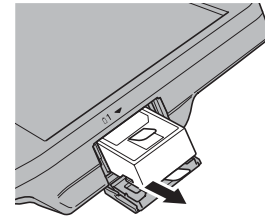

## 3 Insert the new battery pack until it securely fits the connector.

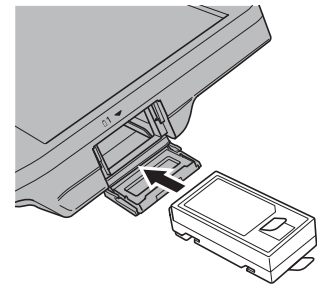

## 4 Close the battery cover.

- ① Close the battery cover.
- ② Slide the battery cover until it clicks.

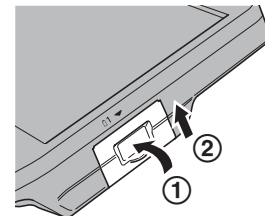

### CAUTION

- Make sure the battery cover is securely locked, otherwise the battery pack may fall when you carry the computer.

## Connecting/Removing USB Devices

You can connect USB devices to the USB ports on the Cradle.  
When you use the USB devices, connect the AC adaptor to the DC-IN jack on the Cradle.

### ■ To connect the USB device

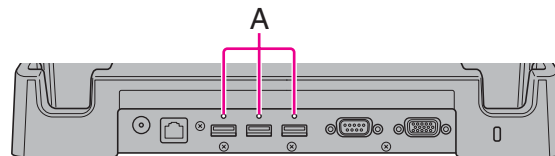

#### 1 Connect the USB device to the USB port.

When using the cable specifically designed for this Cradle, you can tighten screws at position (A).  
For further information, refer to the instruction manual of the USB device.



### ■ To remove the USB device

#### 1 Disable the USB device.

- ① Double-click  on the notification area and select the USB device, then click [Stop].
- ② Follow the on-screen instructions.
  - This step is not necessary when;
    - Removing the device after turning off the computer.
    -  is not displayed.
    - The device does not appear in the list in step ①.

#### 2 Remove the USB device.

### NOTE

- You may need to install the driver for the USB device. Follow the on-screen instructions or refer to the instruction manual of the USB device.
- You may need to install the driver again when connecting the device to another port.
- When a USB device is connected, standby and hibernation may not function normally. If the computer does not start up normally, remove the USB device and restart the computer.
- When the USB device is removed and then inserted,  may appear in the Device Manager and the device may not be correctly recognized. In this case, remove and connect the device again.
- When a USB device is connected, power consumption increases. Remove the USB device when it is not in use, especially when operating by battery power.

You can take still pictures.

- 1 Hold the side of the computer to aim the camera.**
- 2 Press the Camera button (A) to activate the camera.**  
Preview window is displayed.
- 3 Press the Camera button (A) to take a picture.**  
A picture is displayed in the window.
  - Save the picture
  - ① Click [Save] and specify the destination to save and file name, then click [Save].
  - Copy the picture to clipboard
  - ① Click [Copy to Clipboard].
  - Delete the picture
  - ① Click [Delete], and then click [Yes].
- 4 Click [Close] to close the picture window.**

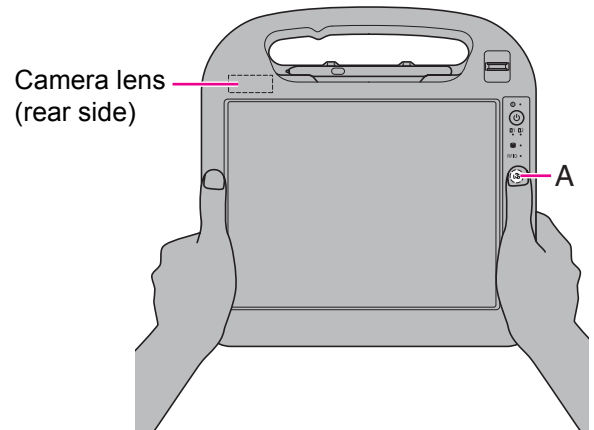

You can read the data from RFID (Radio Frequency Identification) tags.

## NOTE

- RFID Reader is typically used with specialized applications. For further information, ask the system administrator.

**1 Aim the RFID Reader (A) at the center of RFID tag.**

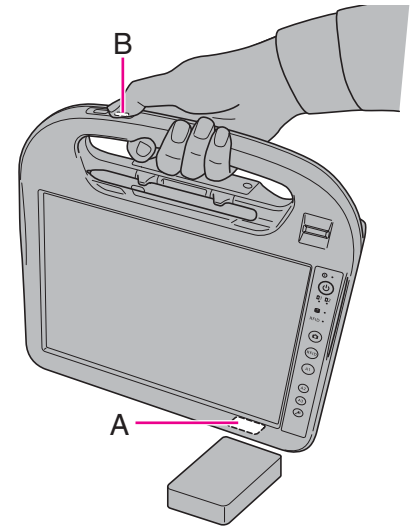

**2 Press the RFID button (B).**

The application which supports the RFID authentication is run, or read data is displayed.

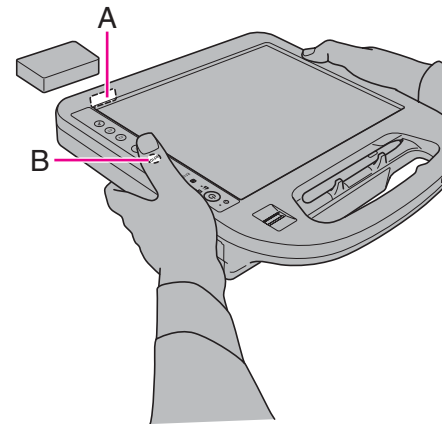

## NOTE

- Operation distance depends on RFID tag.

<Only for model with Fingerprint Reader>

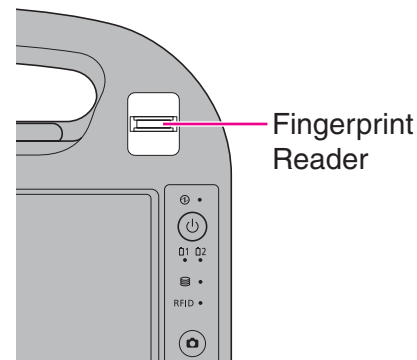

## NOTE

- Enrollment and authentication is unavailable to an extremely minority of people including those whose fingerprints give little data for personal identification.

## How to Use the Fingerprint Reader

This section explains how your fingerprints are enrolled and authenticated.

### 1 Slide your finger.

- To prevent a reading error.
    - ① Set the first joint of your index finger on the sensor as illustrated to the right.
    - ② Slide your finger until it completely crosses.
      - You can slide your finger from both sides.
  - When the fingerprint sensor does not enroll or authenticate your fingerprint properly:
    - You slid your finger too fast or too slow.
    - Your finger was soiled or it has a scar on the surface.
    - Your finger was wet or extremely dry.
    - Your fingerprint does not have sufficient data for personal identification.
- For further information, refer to “Fingerprint Reader” (→ [page 72](#)).

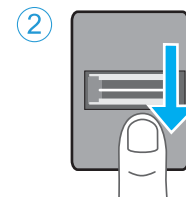
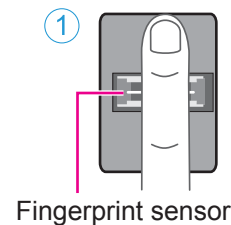

## CAUTION

- We shall not be liable for any loss or damage whatsoever resulting from your Fingerprint device or neglect of Fingerprint device use, or any data loss resulting from such developments as Fingerprint authentication device malfunctioning.



## Overview

### Fingerprint's Outline

The conventional security systems use ID/passwords and token devices such as IC cards to authenticate users. Therefore the passwords and token devices are exposed to the risk of being lost, stolen and hacking.

The Fingerprint authentication method uses user's fingerprints instead of passwords for security authentication. You can use your fingerprints to start up your computer and log on Windows.

We recommend you use the Fingerprint Reader in combination with the TPM (Trusted Platform Module) to increase the security level of your computer.

#### Recommended Installation Procedure

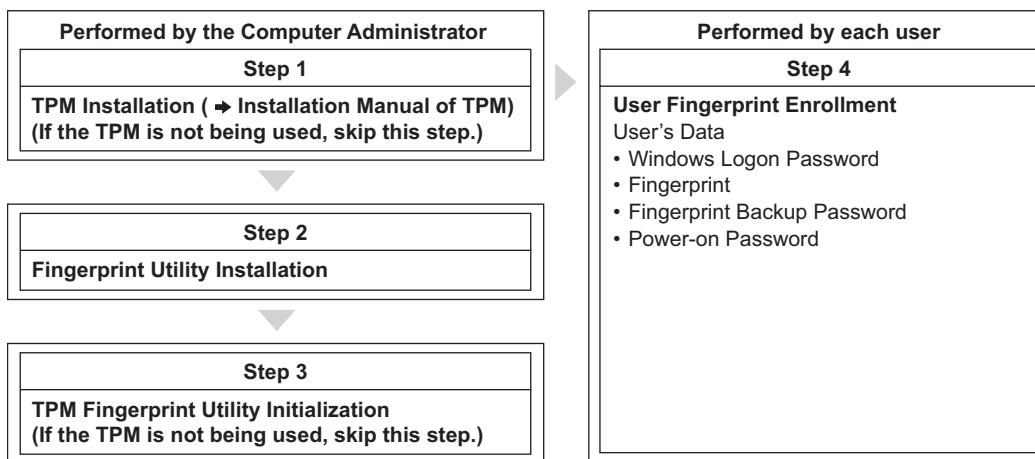

#### ■ To access the online manual

This manual describes Step 2, 3 and the initial part of Step 4.

For further information, refer to the UPEK Protector Suite QL Help menu.

- Click [start] - [All Programs] - [Protector Suite QL] - [Help].

## Precautions

### ■ Security Functions

- Fingerprint Authentication Technology does not guarantee complete authentication and individual identification. Please acknowledge we shall not be liable for any loss or damage whatsoever resulting from the use of, or inability to use your Fingerprint device.
- The Fingerprint authentication method uses multiple fingerprints, encryption keys, credentials data and passwords. You might not be able to use your data if you lose fingerprints, keys, credentials and passwords. Back up the Fingerprint authentication data in a safe place. For further information, refer to “Backup” (→ [page 37](#)).
- General interaction with third-party applications: There is no guarantee that there will not be any negative interaction with any third-party software, and will not accept any responsibility for such an interaction.

## Installation

### 1 TPM Installation

Refer to the Installation manual of “Trusted Platform Module (TPM)”.

- Click [start] - [Run], enter “c:\util\drivers\tpm\readme.pdf”, and click [OK].

### 2 Fingerprint Utility Installation

- ① Log on to Windows as an Administrator.
- ② Close all other programs.
- ③ Click [start] - [Run], enter “c:\util\drivers\fnprint\autorun.exe”, and click [OK].
- ④ Click [Next].  
Installation starts. Follow the on-screen instructions.
- ⑤ When the “Protector Suite \*.\* has been successfully installed.” message appears, click [Finish].  
At the confirmation message, click [Yes].  
The computer restarts.
- ⑥ Log on to Windows as an Administrator.  
The “Protector Suite QL Icon”  appears in the notification area.

### 3 TPM Fingerprint Utility Initialization

Preformed by the Computer Administrator.

The “Invalid TPM status” message is displayed by the “Protector Suite QL Icon”  in the notification area.

- If the TPM is not being used, skip this step.
- ① Click in the “Invalid TPM status” message to start [Advanced Security Initialization Wizard].
  - Follow the on-screen instructions.

## NOTE

- If the “Invalid TPM status” message is not displayed
  - Click [start] - [All Programs] - [Protector Suite QL] - [Control Center] - [Settings] - [System Settings] - [TPM] - [Initialize TPM].

## 4 User Fingerprint Enrollment

Performed by each user.

- ① Click [start] - [All Programs] - [Protector Suite QL] - [User Enrollment].  
Carefully read the License Agreement, select [I Accept the terms of the License Agreement] and click [OK].
- ② Click [Next].
- ③ Select an enrollment mode, and click [Finish].
  - Enrollment mode  
You can make the configuration for the enrollment only once during this initialization phase.
    - Enrollment to the biometric device  
All enrolled fingerprints are stored directly in the fingerprint sensor. The user data will be secured by the hardware protection keys obtained by the fingerprint sensor. The number of the available fingerprints appears in the display.
    - Enrollment to the hard disk  
All enrolled fingerprints are stored on the hard disk. Hardware protection of the user data is not possible, but multiple users can enroll their fingerprints.
  - When the [Finish] screen appears, read the description carefully.
  - [User Enrollment] wizard starts. Follow the on-screen instructions.

## NOTE

- Enroll at least 2 fingers. Even if one of them is injured, you can use another one to access your account and secret data. For further information about the enrollment, refer to “How to Use the Fingerprint Reader” (→ [page 32](#)) and [Fingerprint Tutorial].
  - Click [start] - [All Programs] - [Protector Suite QL] - [Fingerprint Tutorial].
- We recommend you use the Power-on Security feature. This feature prevents unauthorized access to the user’s computer at the BIOS level.  
After first finger enrollment, [Power-on Security] message appears. Select [Yes].
  - ① When the [Power-on Security] screen appears, click [Manage Passwords].
  - ② Select [Power-On] in [Password Types], and click [Set password].
  - ③ Enter the password for [Power-on Security], and click [OK].
  - ④ Click [Close].

- ⑤ Add a check mark for [Power-On] in [Password Types].
- ⑥ Enter the password (step ③), and click [OK].
- ⑦ Click [Next].
  - Follow the on-screen instructions.

## NOTE

- When you use the Power-on-Security feature, the fingerprints are stored in the fingerprint sensor regardless of the selected enrollment mode. The number of the available fingerprints appears in the display.

## More Advanced Security

You can increase your computer's security level by setting the BIOS level described in this section.

When you use this security function, you need to set the computer to the Cradle and connect an external keyboard to the Cradle whenever computer starts.

### Preparation

- Set the computer to the Cradle and connect an external keyboard to the Cradle.

### 1 Register the Supervisor Password.

You have to register the Supervisor Password to proceed to the next step.

If you have already registered the Supervisor Password, you can skip this step, and move on to step 2.

If you have not done this, have enrolled your fingerprint using Protector Suite QL, and have already made Power-on Security effective, after step ②, your fingerprint authentication will be necessary.

- ① Turn on or restart the computer.
- ② Press **F2** or **Del** while [Panasonic] boot screen is displayed soon after the computer starts the startup procedure.
- ③ Select the [Security] menu.
- ④ Select [Setup Supervisor Password], and press **↵** (Enter).
- ⑤ Enter your password in the [Create New Password], and press **↵** (Enter).
  - The password will not be displayed on the screen.
  - You can use up to 32 alphanumeric characters (including spaces).
  - The case (upper/lower) is ignored.
  - You cannot use **Shift** and **Ctrl** to input a password.
- ⑥ Enter your password again in [Confirm New Password], and press **↵** (Enter).

## 2 Set the High Security Level.

- ① Select [Fingerprint Security], and press **↵** (Enter).
- ② Select [Security mode], and select [High].
  - Default setting: Simple
- ③ Press **Esc** to close the sub-menu.
- ④ Press **F10**, select [Yes], and press **↵** (Enter) to exit the Setup Utility.

### NOTE

- In the [High] security mode, you have to enter the Supervisor or User Password even after fingerprint authentication. In the [Simple] security mode, you do not have to enter the Supervisor or User password after fingerprint authentication.

## Useful Information

### Backup

The file described below is necessary for recovering the Fingerprint authentication data. Back up this file periodically in a safe location such as removable disk to avoid data loss resulting from some accidents. We recommend you to store the file in a removable disk or network drive because the benefit of Fingerprint authentication security can be reduced if you keep the file in the internal hard disk drive.

The backup password described below is necessary for bypassing the Fingerprint authentication. We recommend you to set the backup password using the [User Enrollment] wizard. If you do not define the backup password, you may lose your data in case of authentication hardware failure.

- File used by each user
  - Backup user passport data  
(Default name: <UserAccount>.vtp)  
You need this file when you replace the embedded fingerprint chip, or the hard disk drive, or when reinstalling Windows. This file contains the fingerprints, encryption keys, and logon authentication data.

### NOTE

- How to Backup:  
Select [Export] in [Import or Export User Data] to save the user data.
  - Click [start] - [All Programs] - [Protector Suite QL] - [Control Center] - [Fingerprints].For further information, refer to the software's online manual (→ [page 33](#)).

- Password used by each user
  - Backup Password for Enrollment  
This backup password can be used in case of hardware failure to bypass the fingerprint authentication.

## CAUTION

- The passwords other than those explained above are also used for security, so do not lose them. For further information, refer to the software's online manual (→ [page 33](#)).

## Limitations in Use

- Password Bank\*<sup>1</sup> limitations: The following web pages cannot be supported.  
Web pages which are created by the following technologies:
  - Web forms created on the fly using java script.
  - Web forms which looks as one form (e.g. login field, password field), but internally created with 2 independent forms.
  - There can be auto submit problems with web forms which do not have Submit button. All forms that you cannot submit with  (Enter) will be entered by Password Bank, but not submitted.
- Password Bank\*<sup>1</sup> limitations: The following Windows applications cannot be supported.
  - Applications which do not use standard Windows controls and draw controls by their own.
  - This includes any Java based application.

\*<sup>1</sup> For information of these functions, refer to the software's online manual (→ [page 33](#)).

## Handling & Maintenance

- The enrolling and authentication sensitivity may decline under the conditions below. Wipe off stains or moisture on the sensor surface with a soft cloth.
  - The surface of the fingerprint sensor is soiled with dust, skin oil, or sweat.
  - The surface of the fingerprint sensor is wet as a result of moisture or condensation.
- Static electricity may also cause the sensor to malfunction. To make your finger static-free, touch a metal surface before placing it on the fingerprint sensor. Exercise caution against static electricity in winter and other dry conditions.
- Malfunction or damage may occur when:
  - The fingerprint sensor surface was damaged by the strong rubbing of a solid material, scratches, or being pecked with a pointed item.
  - The sensor was touched with a finger soiled with mud, damaging the sensor surface with a tiny substance, and staining the surface.
  - The sensor surface was covered with a seal, or soiled with ink.

## Deleting (Initializing) Owner's Data

---

When you dispose of the computer or transfer the ownership, delete (initialize) the owner's data to avoid unauthorized access.

### NOTE

- The data enrolled in the fingerprint sensor is not image data. You cannot restore fingerprint image data from the data enrolled in the fingerprint sensor.

### 1 Disable Power-on Security

Performed by the Computer Administrator.

- ① Click [start] - [All Programs] - [Protector Suite QL] - [Control Center].
  - The [Fingerprint Control Center] screen appears.
- ② Click [Settings], and click [Power-on Security].
- ③ Remove the check mark from [Enable power-on security using fingerprints], and click [OK].
- ④ Click [Fingerprints], and click [Enroll or Edit Fingerprints].
  - [User Enrollment] wizard starts. Follow the on-screen instructions.
- ⑤ When the [User's Fingers] screen appears, click [Next] without deleting fingerprint samples.
- ⑥ Click [Manage Passwords].
- ⑦ Select [Power-On] in [Password Types], and click [Unset password].
- ⑧ Enter the password for Power-on Security, and click [OK].
- ⑨ Click [Close].
  - Confirm that there is no item in [Password Types].
- ⑩ Click [Next] - [Next].
- ⑪ Click [Finish].
  - Follow the on-screen instructions.

### 2 Delete Fingerprint Data.

Performed by each user.

- ① Click [Fingerprints], and click [Delete].
  - The [Swipe finger] screen will appear.
- ② Swipe user's finger.
  - If the authentication is successfully completed, the confirmation message appears.
- ③ Click [Yes].
  - Confirm that all users' data was deleted.

## NOTE

- If the enrollment mode is set to “Enrollment to the hard disk” (→ [page 35](#)), you need to remove the fingerprints data after step 2. Performed by the Computer Administrator.
  - ① Click [start] - [All Programs] - [Protector Suite QL] - [Control Center].
  - ② Click [Settings], and click [Power-on Security].
  - ③ Select the fingerprint, and click [Remove].
    - Surely remove all of the fingerprints.

## 3 Uninstall Protector Suite

Performed by the Computer Administrator.

- ① Log on to Windows as an Administrator.
- ② Close all programs.
- ③ Click [start] - [Control Panel] - [Add or Remove Programs].
- ④ Click [Protector Suite \*.\*], and click [Change].
- ⑤ Select [Remove].
- ⑥ Select [Remove all Protector Suite \*.\* data], and click [Next].
  - Uninstallation starts. Follow the on-screen instructions.
- ⑦ When the “Protector Suite \*.\* has been successfully uninstalled.” Message appears, click [Finish].
  - If the confirmation message appears, click [Yes].
  - The computer restarts.



## Starting Over

---

If the specific solutions for your problem in Fingerprint Reader (→ [page 72](#)) do not work, you can use these instructions as the last measure and start over. However, please note that you can lose your data - passwords, secret keys and fingerprints.

- ① Log on to Windows as an Administrator.
  - You can always access the computer by using your Windows log on password.  
In convenient mode, any user can access the computer by using the Windows log on password.
- ② Try to export your passport to a file if you are planning to use your passwords, secret keys or enrolled fingers in the future.
  - If you exported your passport recently, this step is not required.
  - If biometrics authorization works and your finger are recognized, use [Import or Export User Data] wizard, swipe your finger and continue according to wizard's instructions.
  - If biometrics authorization works, but your finger is not recognized, you can start the [Import or Export User Data] wizard and export the passport even without using your fingerprint. You need to cancel fingerprint dialog, and you will be prompted for a password. If you do not use [Advanced Security], enter your Windows log on password. Otherwise, enter your [Advanced Security] backup password.

### CAUTION

---

- If you used [Advanced Security] without a backup password. There is no way to backup your data.
    - If biometrics authorization does not work, there is no way to backup your data.
- 

- ③ Deleting the passport.
  - Use the [Delete] wizard. Please note that all your stored secret data (passwords, [File Safe] encryption keys) will be lost. If you backed up the data, you can restore it in the next step; otherwise it will be lost permanently. To perform the delete operation it is necessary to cancel the fingerprint verification operation to get to the password dialog, then enter your Windows log on password or backup password.
- ④ Make sure your fingerprint sensor is working.
  - Use the Tutorial wizard to verify that the fingerprint sensor works. If not, reboot and try again. If it still does not work, please contact Panasonic Technical Support.
- ⑤ Restore or create passport.
  - If you have a backup of your data, you can now use [Import or Export User Data] wizard to restore your data. Otherwise you can create a new passport by using the [Enroll or Edit Fingerprints] wizard.

You can connect external equipment in variety by attaching the computer to the Cradle (optional). For further information, read the operating instructions that comes with the Cradle.

## ■ Setting the computer to the Cradle

- 1 Turn off the computer.**
  - Do not use standby or hibernation function.
- 2 Connect the AC adaptor to the DC-IN jack on the Cradle.**
- 3 Insert the computer to the Cradle from the top, facing the LCD panel to your side.**

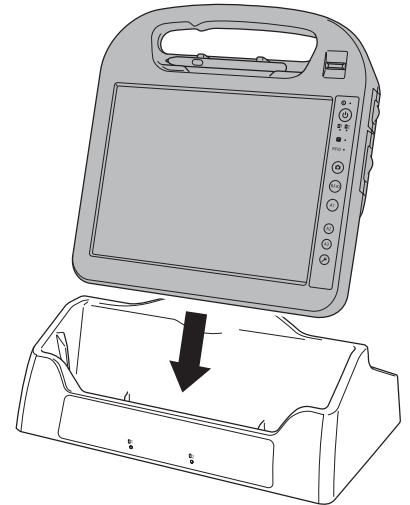

### CAUTION

- Hot or warm docking/undocking is not possible with the Cradle.
- If connector contacts become dirty brush off the dirt. Wipe off the water if attached. Contact failure may occur.



## CAUTION

- Before disconnecting the external display, switch to the internal LCD. Otherwise the displayed image quality may become different after disconnection (e.g., wrong resolution).
- The screen may become distorted due to the following operations. In this case, restart the computer.
  - Disconnecting an external display for which you have set high resolution or high refresh rate.
  - Connecting/disconnecting an external display during computer operations.

## Switching the Display

### 1 Press [A1] button \*1.

Each time you press the button:

Internal LCD → Simultaneous display → External display

↑

- When the display cannot be switched, right-click on the desktop and click [Graphic Properties] to switch the display.

\*1 You can change the setting of application buttons. (→ [page 11](#))

<Only when connected to Cradle>

## Connecting LAN



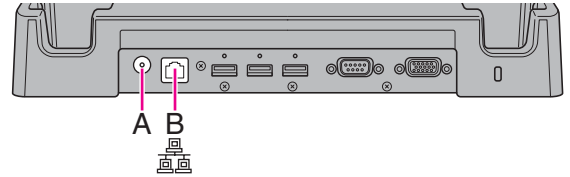

- 1 Turn off the computer.**
  - Do not use standby or hibernation function.
- 2 Connect the AC adaptor to the DC-IN jack (A) on the Cradle.**
- 3 Set the computer to the Cradle.**
- 4 Connect the LAN port (B) and the network system (server, HUB, etc.) by using a LAN cable.**
- 5 Turn on the computer.**



There are 3 ways of disabling and enabling wireless communication.

- Wireless Switch Utility (→ [page 46](#))
- Settings in the [Advanced] menu of the Setup Utility (→ [page 56](#))
- Setting in the Wireless Communication Disable Utility (→ [page 47](#))

## NOTE



- For further information about Wireless LAN: → [page 49](#)
- For further information about Bluetooth: → [page 52](#)
- For further information about Wireless WAN: Refer to the instruction manual of the wireless device.
- To use wireless communication, set the wireless devices ([Wireless LAN] / [Bluetooth] / [Wireless WAN]) to [Enabled] (default) in the [Advanced - Wireless Configuration] menu of the Setup Utility (→ [page 56](#)).
- It may take some time to turn off wireless communication after switching the wireless switch off.
- If the IEEE802.11a setting is changed in [Device Manager] (→ [page 51](#)), the display will be changed accordingly.
- You can check the wireless LAN communication status in Intel® PROSet/Wireless Software. Perform either of the following procedure.
  - Double-click , , , or  on the notification area.
  - Click [start] - [All Programs] - [Intel PROSet Wireless] - [WiFi Connection Utility]

## Wireless Switch Utility

This utility allows you to enable or disable wireless devices from a pop-up menu in the notification area. In the default setting, all wireless devices are enabled.

### ■ The Wireless Switch Utility icon

The icon appears in the notification area when the computer is turned ON. It shows the status of wireless devices.

-  : Indicates that the wireless devices are enabled.
-  : Indicates that the wireless devices are off.
-  : Indicates that the wireless devices have been disabled in the Setup Utility.

### ■ To enable or disable particular wireless devices

- 1 Click the Wireless Switch Utility icon to show the pop-up menu.
- 2 Select ON or OFF for the device you want to enable or disable.

## Wireless Connection Disable Utility

You can automatically disable the wireless LAN/wireless WAN connection when a LAN cable is connected to the Cradle and your computer is set to the Cradle. You need to install the Wireless Connection Disable Utility to use this function.

### Installing the utility

---

- 1** Log on to Windows as an administrator.
- 2** Click [start] and input [c:\util\wdisable\setup.exe] in [Start Search], and press **Enter**.
- 3** Follow the on-screen instructions to install the Wireless Connection Disable Utility.

### Checking the status of the wireless connection

---

#### NOTE

- The Wireless Switch Utility should also be installed so that the Wireless Connection Disable Utility works. The Wireless Switch Utility has already been installed at the factory.
  - The utility does not automatically disable the Bluetooth connection.
-

## ■ Status indication

After installation, the Wireless Connection Disable Utility is automatically started after a user is logged in. An icon appears on the notification area.



: Indicates that

- the utility is enabled, and
- the wireless connection is disabled since a LAN cable is connected.



: Indicates that

- the utility is enabled, and
- the wireless connection is enabled since no LAN cable is connected.



: Indicates one of the following statuses;

- the utility does not monitor the LAN port status,
- the Wireless Switch Utility has not been started, or
- LAN is disabled in the device manager.

## ■ Menu

Right-clicking the utility icon in the notification area opens a menu as follows.

Clicking the menu item causes the following utility action.

### **Monitoring LAN Cable: ON**

Enables the Wireless Connection Disable Utility to monitor the LAN port and disables wireless connection when a LAN cable is connected.

### **Monitoring LAN Cable: OFF**

Disables the Wireless Connection Disable Utility, and enables wireless connection regardless of whether a LAN cable is connected or not.

### **Exit**

Exits the Wireless Connection Disable Utility and enables wireless connection.

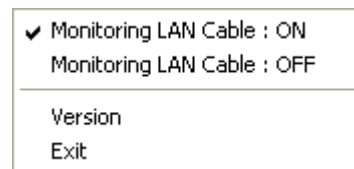



## CAUTION

- **To avoid unauthorized access to the computer through wireless LAN**

We recommend you to make security settings such as encryption before using wireless LAN. Otherwise the hard disk data such as the shared files can be exposed to the risk of unauthorized access.

## NOTE

- Communication is established through the wireless LAN antenna (A). Do not block the antenna area with your hand or body.
- You cannot use the wireless LAN function together with the Fast User Switching function.
- The transmission rate will be lower when a microwave oven is used near by.
- To use wireless LAN, set [Wireless LAN] to [Enabled] (default) in the [Advanced - Wireless Configuration] menu of the Setup Utility (→ [page 56](#)).

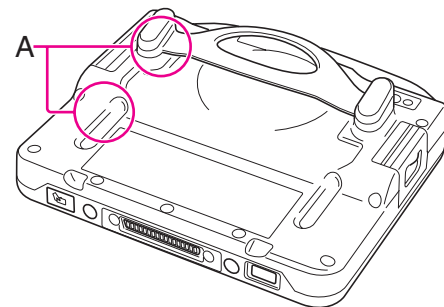





## ■ To turn on/off wireless LAN

→ [page 46](#), Disabling/Enabling Wireless Communication







## ■ To check the wireless LAN communication status

- 1 Place the cursor over the Wireless Switch Utility icon (  or  ) on the notification area. A tooltip appears.

## NOTE

- The Wireless Switch Utility icons (  and  ) indicate the on/off status of wireless communication, not the IEEE802.11a setting.
- If the setting is changed in [Device Manager], the display will be changed accordingly.
- Perform either of the following procedures to check the status in Intel<sup>®</sup> PROSet/Wireless Software.
  - Double-click ,  or  on the notification area.
  - Click [start] - [All Programs] - [Intel PROSet Wireless] - [WiFi Connection Utility].



## Setting the Profiles

- 1 Double-click  /  /  on the notification area.**  
The [Intel® PROSet/Wireless WiFi Connection Utility] screen appears.
  - When  or  is displayed, skip step 2.
- 2 When you double-clicked  in step 1, slide the wireless switch to turn on.**
- 3 Click [Profiles] at the lower right corner of the window, and click [Add].**
- 4 Enter the profile name and WiFi Network Name (SSID), and make other necessary changes, then click [Next].**
- 5 Make necessary settings and click [OK].**
- 6 Select the profile you set and click [Connect].**
- 7 Click [Close].**



### NOTE

- You need to set the profile for each user.
- The settings depend on the network environment. For further information, ask the system administrator or the person in charge of the network.
- For further information of Intel® PROSet/Wireless software, refer to [Help] in the menu bar.

## Enabling/Disabling the Wireless LAN Standard IEEE802.11a (802.11a)

- 1 Click  or  on the notification area.
- 2 Click [802.11a Enabled] or [802.11a Disabled].

### NOTE

- In some countries, communication using IEEE802.11a (5 GHz wireless LAN) standard is restricted by law.
- The Wireless Switch Utility icon (  or  ) indicates the on/off status of wireless LAN and/or Bluetooth and/or wireless WAN, not the setting of IEEE802.11a.
- If IEEE802.11a is enabled or disabled while the computer is connected to an IEEE802.11b/g access point, the connection will be temporarily interrupted.
- You can also change the IEEE802.11a setting in [Device Manager].
  - ① Click [start] - [Control Panel] - [Performance and Maintenance] - [System] - [Hardware] - [Device Manager].
  - ② Double-click [Network adapters] and double-click [Intel(R) WiFi Link 5100].
  - ③ Click [Advanced], and then select [Wireless Mode] in [Property].
  - ④ Remove the check mark from [Use default value] in [Value], and select the settings (e.g., [802.11a and 802.11g]).
  - ⑤ Click [OK].

If you enable or disable 802.11a using the pop-up menu of Wireless Switch Utility, the setting in [Device Manager] will be accordingly changed as below.

Settings in Device Manager	Settings in Wireless Switch Utility	
	When 802.11a is enabled	When 802.11a is disabled
[802.11a, 802.11b and 802.11g] [802.11b and 802.11g]	a+b+g is enabled	b+g is enabled
[802.11g only] [802.11a and 802.11g]	a+g is enabled	g is enabled
[802.11a only] [802.11b only]	a is enabled	b is enabled

You can access internet and other Bluetooth devices without connecting cables.

## NOTE

- Communication is established through the Bluetooth antenna (A). Do not block the antenna area with your hand or body.
- To use Bluetooth, set [Bluetooth] to [Enabled] (default) in the [Advanced - Wireless Configuration] menu of the Setup Utility (→ [page 56](#)).
- The transmission rate will be lower when a microwave oven is used near by.

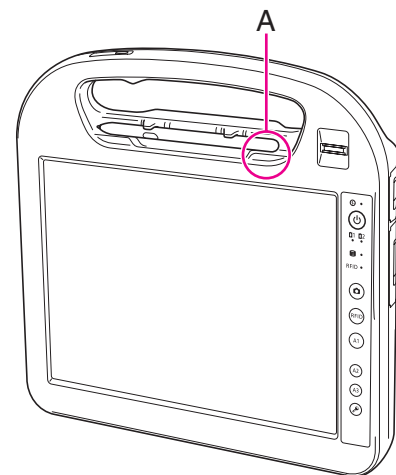

## ■ To turn on/off Bluetooth

→ [page 46](#), Disabling/Enabling Wireless Communication

## ■ To check the Bluetooth communication status

→ [page 46](#), The Wireless Switch Utility icon

## ■ To access the online manual

- 1 Click [start] - [All Programs] - [Bluetooth] - [User's Guide].

You can make the settings of the computer's operating environment (password settings, startup drive selection, etc.)

## Preparation

- Set the computer to the Cradle and connect an external keyboard to the Cradle.

## Starting the Setup Utility

- 1 Turn on or restart the computer.
- 2 Press **F2** or **Del** several times while [Panasonic] boot screen is displayed soon after the computer starts the startup procedure.

When [Enter Password] is displayed, input your password.

### When you start the Setup Utility with Supervisor Password

- You can make the settings of all items of the Setup Utility.

### When you start the Setup Utility with User Password

- Note the following:
  - In the [Advanced] and [Boot] menus, you cannot make the settings of all items.
  - In the [Security] menu, you can change only the User Password when [User Password Protection] is set to [No Protection]. You cannot delete the User Password.
  - In the [Exit] menu, you cannot make the setting of [Load Default Values] and [Boot Override].
  - **F9** (Setup Defaults) does not function.

## Information Menu

Underlined items are the factory presets.

Language	<u>English</u> Japanese
<b>Product Information</b>	Computer information (cannot be changed.)
Model No	
Serial No	
<b>System Information</b>	
Processor Type	
Processor Speed	
Memory Size	
Available Memory	
Hard Disk	
<b>BIOS Information</b>	
BIOS	
Embedded Controller	
Accumulative Operating Time	
Access Level	

## Main Menu

Underlined items are the factory presets.

System Date <ul style="list-style-type: none"> <li>• Month/Day/Year.</li> <li>• You can use <b><u>Tab</u></b> to move the cursor.</li> </ul>	[xx/xx/xxxx]
System Time <ul style="list-style-type: none"> <li>• 24-hr. style.</li> <li>• You can use <b><u>Tab</u></b> to move the cursor.</li> </ul>	[xx:xx:xx]
<b>Main Configuration</b>	
Display <ul style="list-style-type: none"> <li>• The display during the Windows start-up process. When an external display is not connected, the information appears on the internal LCD even though the [External Monitor] is selected.</li> </ul>	<u>External Monitor</u> Internal LCD
Battery Charging Indicator	<u>On Continuous</u> Flashing
Environment	Normal Temperature High Temperature <u>Auto</u>
Battery 1 Current Status <ul style="list-style-type: none"> <li>• Only when [Environment] is set to [Auto].</li> </ul>	Depending on the battery status, either "Normal Temperature" or "High Temperature" is displayed.
Battery 2 Current Status <ul style="list-style-type: none"> <li>• Only when [Environment] is set to [Auto].</li> </ul>	Depending on the battery status, either "Normal Temperature" or "High Temperature" is displayed.

## Advanced Menu

Underlined items are the factory presets.

CPU Configuration	
Execute-Disable Bit Capability	Disabled <u>Enabled</u>
Hyper Threading Technology	Disabled <u>Enabled</u>
Intel (R) Virtualization Technology	<u>Disabled</u> Enabled
Peripheral Configuration	
Legacy USB Support	Disabled <u>Enabled</u>
▶ Wireless Configuration	Enter the sub-menu <sup>*1</sup> .
▶ Serial Port Configuration • Used to configure the GPS and Barcode Reader	Enter the sub-menu <sup>*2</sup> .

\*1 The sub-menu that appears when [Wireless Configuration] is selected:

Wireless LAN.	Disabled <u>Enabled</u>
Wireless WAN • Only for model with Wireless WAN	Disabled <u>Enabled</u>
Bluetooth	Disabled <u>Enabled</u>

\*2 The sub-menu that appears when [Serial Port Configuration] is selected:

GPS • Only for model with GPS	Disabled <u>Enabled</u>
Barcode Reader	Disabled <u>Enabled</u>



## Boot Menu

Underlined items are the factory preset

Boot Option Priorities	
Boot Option # 1	USB Floppy Disk <sup>*3</sup>
Boot Option # 2	Hard Disk
Boot Option # 3	USB Hard Disk
Boot Option # 4	USB CD/DVD Drive

### ■ To change the boot order

The default order is [USB Floppy Disk<sup>\*3</sup>] - [Hard Disk] - [USB Hard Disk] - [USB CD/DVD Drive].

- Press  (Enter) on the boot device you want to change and select the boot device from the following menu.
  - When a selected boot device in the following menu already exists in either of the [Boot Option (#1 to #4)], the boot device appears at the newly selected position by switching the positions with the original boot device that existed before at the position.
  - When you select [Disabled] in the following menu, the disabled [Boot Option] is ignored and the boot device in the next [Boot Option] operates.
    - [USB Floppy Disk]<sup>\*3</sup>
    - [Hard Disk]
    - [USB Hard Disk]
    - [USB CD/DVD Drive]
    - Disabled

<sup>\*3</sup> Use the Panasonic USB floppy disk drive (optional: CF-VFDU03U)

#### NOTE

- To boot from the following devices, make the settings as below.

To boot from

You need to set

- USB connected device : [Legacy USB Support] to [Enabled] (→ [page 56](#))

## Security Menu

Underlined items are the factory presets.

Boot Prompt Configuration	
Setup Utility Prompt <ul style="list-style-type: none"> <li>When [Setup Utility Prompt] is set to [Disabled], the message “Press F2 for Setup” is not displayed on [Panasonic] boot screen. However <b><u>F2</u></b> and <b><u>Del</u></b> will work even if the message is not displayed.</li> </ul>	Disabled <u>Enabled</u>
Password on Boot	Disabled Enabled* <sup>4</sup>
Set Supervisor Password	Enter the sub-menu.
Hard Disk Lock <ul style="list-style-type: none"> <li>Can be changed only when [Set Supervisor Password] is set.</li> </ul>	Disabled Enabled
User Password Protection	<u>No Protection</u> Protected
Set User Password <ul style="list-style-type: none"> <li>Can be changed only when [Set Supervisor Password] is set.</li> </ul>	Enter the sub-menu.
▶ Embedded Security (TPM)	Enter the sub-menu.
▶ Fingerprint Security	Enter the sub-menu.

\*<sup>4</sup> You need to set the computer to the Cradle and connect an external keyboard to the Cradle, when the computer starts.

## Exit Menu

Save Values and Reboot	Reboot the system after saving the changes.
Reboot Without Saving Changes	Reboot the system without saving the changes.
<b>Save Options</b>	
Save Current Values	Save the changes for all Setup options.
Load Previous Values	Load previous values for all Setup options.
Load Default Values	Load default values for all Setup options.
<b>Boot Override</b>	
(Device Information)	To select a boot device which operates only in the next booting.

If it appears that the hardware installed in this computer is not operating properly, you can use the PC-Diagnostic Utility to determine whether or not there is a problem.

If the utility discovers a problem in the hardware, contact Panasonic Technical Support.

Software cannot be checked using this utility.

## Preparation

- Set the computer to the Cradle and connect an external keyboard and a mouse to the Cradle.

## Hardware that can be checked using the PC-Diagnostic Utility

- CPU/Systems (check CPU)
- RAM XXX MB (check Memory)
- HDD XXX GB (check Hard Disk)
- Video (check Video Controller)
- Sound<sup>\*1</sup>
- Wireless LAN
- Wireless WAN<sup>\*2</sup>
- Bluetooth
- GPS<sup>\*3</sup>
- Touchscreen

<sup>\*1</sup> When the diagnostic utility is running, a loud beep will sound, so do not use headphones at this time. (The beep will not sound if mute is using Windows.)

<sup>\*2</sup> Only for model with wireless WAN

<sup>\*3</sup> Only for model with GPS

- When the video diagnostic check is running, the display may be distorted, and when the audio diagnostic check is running, sounds may be generated from the speaker. These are not malfunctions.

## Regarding the PC-Diagnostic Utility

### NOTE

- For the hard disk drive and memory only, you can select standard diagnostic check or extended diagnostic check. When the PC-Diagnostic Utility starts up, it will run the standard diagnostic check.
- You cannot operate the PC-Diagnostic Utility by touching the screen.

Operations	External mouse operations	Keyboard operations
Select icon	Place the cursor above the icon	Press <b>Space</b> . and then press <b>→</b> <b>←</b> <b>↑</b> <b>↓</b> (( <input type="checkbox"/> close) cannot be selected)
Click the icon	Click (right click cannot be used)	Press <b>Space</b> above the icon
Complete the PC-Diagnostics Utility and then restart the computer	Click <input type="checkbox"/> (close)	Press <b>Ctrl + Alt , Del</b> .

## Running the Diagnostic Check

Run this utility using the default settings in the Setup Utility.

If the Setup Utility or other settings will not allow hardware to be executed, the hardware icon will be displayed in gray.

### 1 Connect the AC adaptor.

During the diagnostic check, do not remove the AC adaptor, or attach any peripheral devices.

### 2 Turn on or restart the computer, and press **F2** or **Del** while [Panasonic] boot screen is displayed.

The Setup Utility starts up.

- If the password is requested, enter the Supervisor Password.
- If you are using the computer after changing the settings from the status at the time of purchase, we recommend that you make a note of the settings that are changed.

### 3 Press **F9**.





At the confirmation message, select [Yes] and press **↵** (Enter).

## 4 Press **F10**.

At the confirmation message, select [Yes] and press **↵** (Enter).  
The computer will restart.

## 5 Press and hold **Ctrl + F7** while [Panasonic] boot screen is displayed.

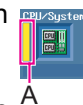

When the PC-Diagnostic Utility starts up, it will automatically begin the diagnostic check for all hardware components.

- If the password is requested, enter the password.
- Do not touch the screen.
- The keyboard cannot be used until alternating blue and yellow colors are displayed on the left side of the hardware icon (A).
- By clicking the icon, you can execute the following operations:
  -  : Start the diagnostic check from the beginning
  -  : Stop the diagnostic check (You cannot restart the check partway through by clicking )
  -  : Display help (click the screen or press **Space** to return to the original diagnostic check screen)
- You can check the status of the diagnostic check by the display color on the left side of the hardware icon (A).
  - Aqua: Not running diagnostic check
  - Alternating blue and yellow: Currently running diagnostic check. The interval of the alternating colors differs depending on the type of diagnostic check currently running.  
During memory diagnostic check, the display may freeze for a long period of time. Wait until the process is complete.
  - Green: No problems discovered
  - Red: Problems discovered



### NOTE

- Using the following procedure, you can run a diagnostic check on a specified hardware component, or run an extended diagnostic check on the memory or the hard disk (The extended diagnostic check is only for the memory and the hard disk). The extended diagnostic check is more detailed, and so requires a longer period of time to run.

- ① Click  to stop the diagnostic check.
- ② Click the icon for the hardware that is not to be checked, so that the icon is displayed in gray (B).  
When running a check on the memory or the hard disk, clicking the icon once will turn on the extended diagnostic check ("FULL" (C) will be displayed below the icon); click again, and the icon will be displayed in gray (D).
- ③ Click  to start the diagnostic check.



e.g. hard disk

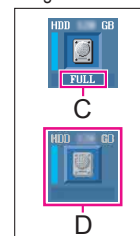

## 6 When all the hardware has been checked, confirm the diagnostic check results.

If the display is red and the message “Check Result TEST FAILED” is displayed, you can assume that there is a problem with the computer’s hardware. Confirm which hardware component is displayed as red, and contact Panasonic Technical Support.

If the display is green and the message “Check Result TEST PASSED” is displayed, the computer’s hardware is operating normally. Continue using the computer as it is. If the computer still does not operate properly, reinstall the software. (⇒ *OPERATING INSTRUCTIONS* “Reinstalling Software”)

## 7 After the diagnostic check is complete, click (close), or press **Ctrl + Alt + Del** to restart the computer.

When disposing the computer or transferring the ownership, erase all hard disk data in order to avoid data leakage. Even if you erase the data or initialize the hard disk using normal Windows commands, the data can be read with some special software. Use the hard disk data erase utility to erase the data completely.

Note that transferring of the ownership without uninstalling the commercial software will be a violation of the software's license agreement.

The flash memory data erase utility erases data using an overwriting method, but there is a possibility that due to malfunctions or other operational errors, data may not be completely erased. There are also specialized devices that may be able to read data that has been erased using this method. If you need to erase highly confidential data, we recommend that you contact a company that specializes in this process. Panasonic Corporation will bear no responsibility for losses or damages suffered as a result of the use of this utility.

## NOTE

- You cannot choose a specific partition to erase data.

## Preparation

- Prepare the following items:
  - The Product Recovery DVD-ROM for Windows Vista (included)
  - Panasonic USB CD/DVD drive (optional) (refer to recent catalogs and other sources for information about the products available)
  - Set the computer to the Cradle and connect an external keyboard and mouse to the Cradle.
- Remove all peripherals (except for the CD/DVD drive and the keyboard).
- Connect the AC adaptor and do not remove it until hard disk data erase is complete.
- Use the external keyboard and the mouse to operate the following steps.

- 1 Turn off the computer and connect the CD/DVD drive to the USB port on the Cradle.**
- 2 Turn on the computer, and press and hold **F2** or **Del** while [Panasonic] boot screen is displayed.**

The Setup Utility starts up.

  - If the password is requested, enter the Supervisor Password.
- 3 Press **F9**.**
  - At the confirmation message, select [Yes] and press **↵** (Enter).
- 4 Set the Product Recovery DVD-ROM into the CD/DVD drive.**
- 5 Select the [Exit] menu, then select your CD/DVD drive in [Boot Override].**
- 6 Press **↵** (Enter).**



- The computer will restart.
- If [Enter Password] is displayed during the following procedures, input the Supervisor Password or the User Password.

- 7** Click [Erase the whole data on the Hard Disk for security] and click [Next].
- 8** At the confirmation message, click [YES].
- 9** Click [Continue].
- 10** Click [Continue] again.
- 11** Click [YES].  
Erasing the hard disk data status.
- 12** After erasing is completed, remove the Product Recovery DVD-ROM and click [OK].

Follow the instructions below when an error message or code appears. If the problem persists or if the error code/message is not shown here, contact Panasonic Technical Support.

Error Code/Message	Solution
<b>Bad System CMOS</b>	An error has occurred in the memory of system settings. This occurs when the memory content is changed by an unexpected program operation, etc. <ul style="list-style-type: none"><li>● Start the Setup Utility and return the settings to the default values, and then change the settings as necessary.</li><li>● If the problem persists, the internal clock battery may need to be replaced. Contact Panasonic Technical Support.</li></ul>
<b>System CMOS Checksum Error</b>	
<b>Invalid Year. System date restored to 01/01/2008</b>	The date and time settings are not correct. <ul style="list-style-type: none"><li>● Start the Setup Utility and set the correct date and time.</li><li>● If the problem persists, the internal clock battery may need to be replaced. Contact Panasonic Technical Support.</li></ul>
<b>Press &lt;F2&gt; to enter setup</b>	<ul style="list-style-type: none"><li>● Write down the error details and press <b>F2</b> or <b>Del</b> to start the Setup Utility. Change the settings if necessary. (→ <a href="#">page 53</a>)</li></ul>

## Network Connections and Communications Software

Close the communications software before using the power saving function.

- If the power saving function (standby or hibernation) is activated while communications software is used, the network connection may be interrupted, or the performance may be adversely affected. In this case, restart the computer.
- In a network environment, set the [System standby] and [System hibernates] settings to [Never].  
Click [start] - [Control Panel] - [Performance and Maintenance] - [Power Options] - [Power Schemes].

## Regarding Windows XP

You can select the Classic view of Control Panel or the Classic Start menu. You can also change the way a user logs on or off. This manual explains using the Windows XP default setting (not Classic view or Classic Start menu etc.).

- Windows Update  
You can update to the latest patches and service packs for Windows with the following menus.  
Click [start] - [All Programs] - [Windows Update].  
Do not apply “Driver Updates” even if a message to update a driver appears. If a driver update is required, contact your technical support office.
- If the message “Your computer might be at risk” is displayed  
Select  (red icon) on the notification area and make the appropriate settings. The Windows Security Center regularly gives you notice so that you can make the optimum settings. This is not an error message and you can use the computer. However, making appropriate measures is recommended to reduce the risk of virus and other attacks.

## Using the Windows Associated Files

The Windows files included in the retail version of the Windows CD-ROM for OS are contained in the following folders:  
c:\windows\docs, c:\windows\dotnetfx, c:\windows\i386, c:\windows\support, c:\windows\valueadd

Refer to the following instructions when a problem occurs. If the remedies indicated in the chart do not solve the problem, contact Panasonic Technical Support. For a software problem, refer to the instruction manual of the software.

- To check the computer's usage status (→ [page 76](#)).



## ■ Shut Down

Cannot shut down or restart Windows.	<ul style="list-style-type: none"><li>● Remove USB devices.</li><li>● It may take 1 or 2 minutes to shut down.</li></ul>
--------------------------------------	--

## ■ Standby or Hibernation

Cannot enter standby or hibernation.	<ul style="list-style-type: none"><li>● Remove USB devices temporarily. If the problem persists, restart the computer.</li><li>● It may take 1 or 2 minutes to enter standby or hibernation.</li><li>● The computer does not enter standby or hibernation immediately after resuming. Wait approximately 1 minute.</li></ul>
Cannot enter standby or hibernation automatically.	<ul style="list-style-type: none"><li>● Disconnect peripheral devices.</li><li>● If you connect to a network using wireless LAN function, select the profile and connect to the access point (→ <a href="#">page 50</a>).</li><li>● If you do not use wireless LAN function, turn off wireless LAN function (→ <a href="#">page 46</a>). If you use wireless LAN function, refer to "To enter sleep on hibernation" (→ <a href="#">page 16</a>) to enter sleep on hibernation.</li><li>● Make sure that you are not using any software that regularly accesses the hard disk. Check that the software which constantly access to the hard disk or place burden on CPU are not used.</li></ul>



## ■ Sound

No sound.	<ul style="list-style-type: none"><li>● Click  or  on the notification area and change the volume.</li><li>● Restart the computer.</li></ul>
Distorted sound.	<ul style="list-style-type: none"><li>● Stop and restart playback.</li></ul>
"There was an error updating the registry" appears when Sound Recorder is started.	<ul style="list-style-type: none"><li>● Sound Recorder is started by a limited account user whose language setting is not the same as the administrator user who last started Sound Recorder. This does not affect the operation.</li></ul>







## ■ Keyboard

Cannot enter special characters (ß, à, ç, etc.) and symbols.	<ul style="list-style-type: none"><li>● Use the character map. Click [start] - [All Programs] - [Accessories] - [System Tools] - [Character Map].</li></ul>
--	---

## ■ Network

Cannot connect to network.	<ul style="list-style-type: none"> <li>● Set LAN (→ <a href="#">page 45</a>).</li> </ul>
Cannot check the computer's MAC address.	<ul style="list-style-type: none"> <li>● Follow the steps below.             <ol style="list-style-type: none"> <li>① Click [start] - [All Programs] - [Accessories] - [Command Prompt].</li> <li>② Input "ipconfig/all", and press  (Enter).</li> <li>③ Write down the 12-digit string of alphanumeric displayed in the "Physical Address" line of the LAN or the wireless LAN (only for model with wireless LAN).</li> <li>④ Input [exit], and press  (Enter).</li> </ol> </li> </ul>

## ■ Wireless Communication

Cannot connect to a network.	<ul style="list-style-type: none"> <li>● Set the device ([Wireless LAN] / [Bluetooth] / [Wireless WAN]) to [Enabled] in the [Advanced] menu of the Setup Utility (→ <a href="#">page 56</a>).</li> <li>● Disable the Wireless Communication Disable Utility (→ <a href="#">page 47</a>).</li> <li>● Restart the computer.</li> </ul>
Access point is not detected.	<ul style="list-style-type: none"> <li>● Confirm that  /  /  is displayed on the notification area.</li> </ul> <p>If  /  /  is not displayed on the notification area, turn on the wireless communication (→ <a href="#">page 46</a>).</p>

## ■ Connecting Peripherals

An error occurs while installing the driver.	<ul style="list-style-type: none"> <li>● When you install a driver of card or peripheral device, make sure that the driver is compatible with the operating system. If it is not compatible, malfunction may occur. For information about the driver, contact the manufacturer of the peripheral device.</li> </ul>
--	---

## ■ Connecting Peripherals

<p>A peripheral device does not work.</p>	<ul style="list-style-type: none"> <li>● When you use the Cradle, connect the AC adaptor to the DC-IN jack on the Cradle.</li> <li>● Install the driver.</li> <li>● Contact the manufacturer of the device.</li> <li>● When operation resumes from standby or hibernation, devices such as a mouse may not function properly. In this case, restart the computer or reinitialize the device.</li> <li>● When  is displayed in the Device Manager, remove and insert the device. If the problem persists, restart the computer.</li> <li>● The computer may not recognize the connection/removal of some devices, or may not operate normally with some devices. Operate the following steps.             <ol style="list-style-type: none"> <li>① Click [start] - [Control Panel] - [Performance and Maintenance] - [System] - [Hardware] - [Device Manager].</li> <li>② Select the device and remove the check mark for [Allow the computer to turn off this device to save power.] in [Power Management]. (This item may be unavailable for some types of devices.)</li> </ol> </li> </ul>
<p>USB floppy disk drive does not work as a boot drive.</p>	<ul style="list-style-type: none"> <li>● You can use only the Panasonic CF-VFDU03U USB floppy disk drive (optional).</li> <li>● Set [Legacy USB support] to [Enabled] in the [Advanced] menu of the Setup Utility (→ <a href="#">page 56</a>).</li> <li>● Set [Boot Option #1] in [Boot] menu of the Setup Utility to [USB FDD Disk]. (→ <a href="#">page 57</a>).</li> <li>● Turn off the computer and connect the USB floppy disk drive, and then restart the computer.</li> </ul>
<p>You do not know the address map for IRQ, I/O port address, etc.</p>	<ul style="list-style-type: none"> <li>● To check the current address map, click [start] - [Control Panel] - [Performance and Maintenance] - [System] - [Hardware] - [Device Manager] - [View] - [Resources by type].</li> </ul>

## ■ Connecting Peripherals

LAN transmission speed slows down noticeably.  
Wireless LAN connection is cut.

- These problems may occur due to performance loss that results from the CPU power-saving function. Log on to Windows as an administrator and follow the steps below.
  - ① Click [start] - [Run] and input [c:\util\cpupower\setup.exe], and click [OK]. Follow the on-screen instructions.
  - ② Click [start] - [All Programs] - [Panasonic] - [CPU Idle Setting].
  - ③ Click [Performance] and click [OK], then click [Yes].

The computer will restart.

    - If the problem persists, click [start] - [Control Panel] - [Performance and Maintenance] - [Power Options] - [Power schemes], select [Always On] in [Power schemes], and click [OK].
- The above remedy is effective for performance loss resulting from the CPU power saving function, but not for other causes (e.g., noise generated by high CPU load such as video playback).
- The above remedy slightly reduces the battery operation time. Normally it is recommended to select [Battery (Windows XP Standard)] in [CPU Idle Setting] and to select [Portable/Laptop] in [Power schemes].

## ■ Touch Screen Operation

Cannot point the correct position using the included stylus.

- Perform the calibration (→ [page 5](#)).

## ■ Fingerprint Reader

<p>The sensor does not enroll or authenticate my fingerprint.</p>	<ul style="list-style-type: none"> <li>● Slide your finger correctly. For further information about enrollment and authentication, refer to “How to Use the Fingerprint Reader” (→ <a href="#">page 32</a>) and [Fingerprint Tutorial].             <ul style="list-style-type: none"> <li>• Click [start] - [All Programs] - [Protector Suite QL] - [Fingerprint Tutorial].</li> </ul> </li> <li>● The sensor enrolls or authenticates no fingerprint, or performs authentication poorly, despite the correct way of finger sliding when your finger is in any of the conditions stated below:             <ul style="list-style-type: none"> <li>• Rough skin, or injured finger (with a cut or a skin inflammation)</li> <li>• Extremely dry</li> <li>• Soiled with mud or oil</li> <li>• Fingerprint has been worn and has faded</li> <li>• Wet with water or sweat</li> </ul> <p>&lt;You can improve enrolling and authentication sensitivity by taking the following steps when any of the conditions described above exists&gt;</p> <ul style="list-style-type: none"> <li>• Wash your hands or wipe them dry.</li> <li>• Use a different finger for registration or authentication.</li> <li>• Treat your finger with a hand cream when it is rough skin or dry.</li> </ul> </li> <li>● Clean the fingerprint sensor. For further information, refer to “Handling &amp; Maintenance” (→ <a href="#">page 38</a>).</li> <li>● The fingerprint sensor may be malfunctioning when it continues to perform poorly after the steps described above have been performed. Contact Panasonic Technical Support.</li> </ul>
<p>Sensor does not work.</p>	<ul style="list-style-type: none"> <li>● Exported passport can help you if you need to replace the sensor.             <ul style="list-style-type: none"> <li>• Log on to Windows as an Administrator. You can always access the computer by using your Windows log on password. In convenient mode, any user can access the computer by using your Windows log on password.</li> <li>• To access [File Safe] [File Safe] can be always accessed by using the [File Safe] backup password.</li> <li>• Other functions Replace/Repair the sensor, then follow the instructions in section “Replacing sensor.” (→ <a href="#">page 73</a>).</li> </ul> </li> <li>Some limited functions (e.g. deleting passport) is available without a functional sensor. In case of deleted operation, it is necessary to cancel the fingerprint verification operation to get to the password dialog.</li> </ul>



## ■ Fingerprint Reader

<p>User cannot use enrolled finger. (e.g. injury)</p>	<ul style="list-style-type: none"> <li>● It is strongly recommended to enroll at least 2 fingers to avoid this problem. If you enrolled multiple fingers, simply use other finger. If you only enrolled one finger that can be used, we recommend to use the [Enroll or Edit Fingerprints] wizard and enroll additional fingerprints.</li> </ul> <p>If none of your enrolled fingers can be used, follow this procedure:</p> <ol style="list-style-type: none"> <li>① Log on to Windows as an Administrator. You can always access the computer by using your Windows log on password. In convenient mode, any user can access the computer by using your Windows log on password.</li> <li>② Update the enrolled fingerprints. To be able to fully use Protector Suite QL, you need to have usable enrolled fingerprints. Enter the [Enroll or Edit Fingerprints] wizard.</li> </ol> <ul style="list-style-type: none"> <li>• If you do not use [Advanced Security], you can still enter using the Windows password.</li> <li>• If you use [Advanced Security] with backup password, you can enter using the backup password.</li> <li>• If you use [Advanced Security] without backup password, there is no other way to add a different fingerprint. In this case we recommend either to wait until your finger is usable again (e.g. the injury heals), or to delete the passport (Use [Delete] wizard) and then reenroll new fingerprints. Please note that in the latter case all your stored secret data (passwords, [File Safe] encryption keys) will be lost. To perform the delete operation it is necessary to cancel the fingerprint verification operation to get to the password dialog, then enter your Windows log on password.</li> <li>• To access [File Safe] If you did not perform the procedure in step ② or it did not work, you can still access [File Safe] by using the [File Safe] backup password.</li> </ul>
<p>Replacing sensor.</p>	<ul style="list-style-type: none"> <li>● If you need to replace a non-functioning Fingerprint Reader, follow this procedure. Enrollment to the hard disk: If enrollment to hard disk is used, "Protector Suite QL" has not stored any data on the device and therefore has no problem to continue after you replaced the sensor. However, in case you use the Power-on security (Preboot Authentication), you may need to use the [Enroll or Edit Fingerprints] wizard to update the related data. Enrollment to the device: If the fingerprint has been enrolled to the device, a new passport will be required. Follow the procedure in the section "Starting Over".</li> </ul>

## ■ Fingerprint Reader

<p>Lost [Advanced Security] backup password.</p>	<ul style="list-style-type: none"> <li>● To change the [Advanced Security] backup password, go to the [Enroll or Edit Fingerprints] wizard and swipe your finger and go through the Fingerprint enrollment. On the Advanced Security page you can change the backup password.</li> </ul>
<p>Protector Suite QL reinstallation.</p>	<ul style="list-style-type: none"> <li>● During Protector Suite QL uninstallation, you can select whether to delete the Protector Suite Data - including passports.</li> <li>● If you want to reinstall the product, select button to leave the Protector Suite QL data on the computer. After the new installation, you will be able to use your data again.</li> <li>● If the Protector Suite QL was uninstalled including the passports, then in case of enrollment to device the fingerprints will still be stored in the device and the user can use them reenrollment.</li> </ul>
<p>Lost [File Safe] backup password.</p>	<ul style="list-style-type: none"> <li>● It is necessary to change the backup password for [File Safe], refer to the software's online manual (<a href="#">→ page 33</a>).</li> </ul>
<p>Accessing [File Safe] after Protector Suite QL uninstallation.</p>	<ul style="list-style-type: none"> <li>● [File Safe] data can be accessed only using Protector Suite QL. If you accidentally uninstalled Protector Suite QL, you have to reinstall it. If passport data was not removed during uninstallation, everything will work automatically including [File Safe]. If the passport data was removed during uninstallation the [File Safe] will recognize that the installation was changed and will offer to use the backup password, instead.</li> </ul>
<p>Accessing [File Safe] after computer crash.</p>	<ul style="list-style-type: none"> <li>● If you have an exported passport, import it now so you can access [File Safe] directly using fingerprints. Otherwise you can access [File Safe] using the [File Safe] backup password: [File Safe] will recognize that the installation was changed and will offer to use the backup password, instead.</li> </ul>
<p>Removing data from the Reader.</p>	<ul style="list-style-type: none"> <li>● When enrollment to the device is used, passport data is stored to the device. To remove it, go to the [Delete] passport wizard and delete existing passports, and then use the [Fingerprint Storage Inspector] to remove remaining fingerprints (e.g. left over from previous installations).</li> <li>● In convenient mode, the [Fingerprint Storage Inspector] does not allow deleting the last fingerprint for an existing passport and only user's own fingerprints can be deleted. Therefore it is necessary to delete passports first.</li> </ul>

## ■ Fast User Switching Function

Some applications do not work properly.	<ul style="list-style-type: none"><li>● When switching to a different user with the Fast User Switching function, the following problems may occur. We recommend you not to use the Fast User Switching function.<ul style="list-style-type: none"><li>• Some applications may not work properly.</li><li>• The display settings may not be possible.</li><li>• Wireless LAN cannot be used.</li><li>• Bluetooth cannot be used.</li></ul></li><li>● In these cases, log off all users without using Fast User Switching function and perform the operation once more. If the problem persists, restart the computer.</li></ul>
---	---

## ■ Screen Saver

“Could not find any compatible Direct3D devices” appears.	<ul style="list-style-type: none"><li>● Do not use a 3D screen-saver.</li></ul>
---	---

## ■ Others

No response.	<ul style="list-style-type: none"><li>● Press [↵] button to open Task Manager, then close the software application.</li><li>● An input screen (e.g., password input screen at startup) may be hidden behind another window. Use <b>Alt + Tab</b> to check.</li><li>● Shut down by pressing and holding the power switch for 4 seconds or longer, and turn on the computer and open the application again. If Windows runs correctly, but the application software does not start, click [start] - [Control Panel] - [Add or Remove Programs] and remove the failing application software, then reinstall the application software.</li></ul>
--------------	--

## Checking the Computer's Usage Status

You can check the computer's usage status in the PC Information Viewer. You may need this information when calling Panasonic Technical Support for advice.

### NOTE

- This computer periodically records the management information of the hard disk etc. The maximum data volume for each record is 1024 bytes. The information is only used for estimating the cause when the hard disk goes down by any possibility. They are never sent to outside via network nor used for any other purpose except for the purpose described the above.

To disable the function, add a check mark for [Disable the automatic save function for management information history] in [Hard Disk Status] of PC Information Viewer, and click [OK].

- If you have not logged on with the administrator authority, some information will be displayed as [Not Found].
- As long as it is activated, the PC Information Viewer will appear in front of all other screens.

**1** Click [start] - [All Programs] - [Panasonic] - [PC Information Viewer] - [PC Information Viewer].

**2** Select the item to display the detailed information.

### ■ To save the information as a text file

**1** Display the information you want to save.

**2** Click [Save].

**3** Select the file save range option and click [OK].

**4** Select the folder to save the information, input the file name, and click [Save].

- If automatic saving of the management information record has not been disabled, the records already recorded are also saved.

### ■ To save a copy of the screen as an image file

**1** Display the screen you want to save.

**2** Click [start] - [All Programs] - [Panasonic] - [PC Information Viewer] - [Screen Copy].

## 3 When the screen copy message appears, click [OK].

The screen image is saved in [My Documents] folder.

### NOTE

- The image is a bitmap file in 256 colors.
- When using the extended desktop (→ [page 43](#)), a copy of the primary device screen is saved.
- The default key combination to copy is **Ctrl** + **Alt** + **F7**. You can change it in the following procedure.
  - ① Log on to Windows as an administrator, and click [start] - [All Programs] - [Panasonic] - [PC Information Viewer].
  - ② Right-click [Screen Copy] and click [Properties] - [Shortcut].
  - ③ Click [Shortcut key] and press the key(s) you want to use for the shortcut.
  - ④ Click [OK].

- Disclaimer

Computer specifications and manuals are subject to change without notice. Panasonic Corporation. assumes no liability for damage incurred directly or indirectly from errors, omissions or discrepancies between the computer and the manuals.

- Trademarks

- Microsoft, Windows, and the Windows logo are registered trademarks or trademarks of Microsoft Corporation of the United States and/or other countries.
- Intel, Core and PROSet are either registered trademarks or trademarks of Intel Corporation.
- Adobe, the Adobe logo and Adobe Reader are either registered trademarks or trademarks of Adobe Systems Incorporated in the United States and/or other countries.
- Bluetooth™ is a trademark owned by Bluetooth SIG, Inc., U.S.A. and licensed to Panasonic Corporation.
- Names of products, brands, etc., appearing in this manual are trademarks or registered trademarks of their respective own companies.